

**Danby**  
**Premiere**®

Owner's Use and Care Guide  
Guide d'utiliser et soins de Propriétaire

Model • Modèle

**DDR50A2GP, DDR60A2GP, DDR70A2GP**  
**DDR60A1CP**

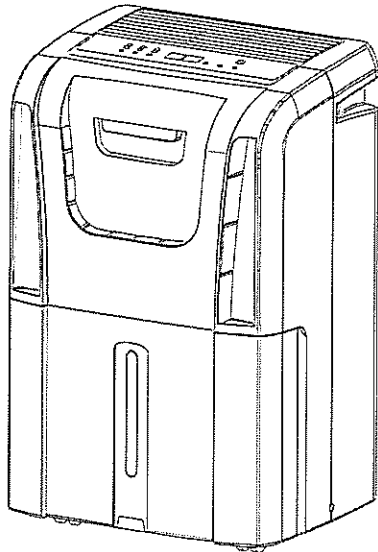

**CAUTION:**

Read and follow all safety rules and operating instructions before first use of this product.

**PRÉCAUTION:**

Veillez lire attentivement les consignes de sécurité et les directives d'utilisation avant l'utilisation initiale de ce produit.

**PORTABLE DEHUMIDIFIER**

**Owner's Use and Care Guide**

..... 1 - 10

- Welcome
- Important Safety Information
- Installation Instructions
- Features
- Operating Instructions
- Care and Maintenance
- Troubleshooting
- Warranty

**DÉSHUMIDIFICATEUR PORTATIF**

**Guide d'utilisation et soins de Propriétaire**

..... 11 - 20

- Bienvenue
- Consignes de Sécurité Importante
- Consignes d'installation
- Caractéristiques
- Consignes de Fonctionnement
- Soins et Entretien
- Dépannage
- Garantie

**KEEP THESE INSTRUCTIONS FOR FUTURE REFERENCE: If the Dehumidifier changes ownership, be sure this manual accompanies the unit.**

**CONSERVER CES INSTRUCTIONS POUR CONSULTATION ULTERIEURE: En cas de revente du déshumidificateur, ce manuel doit être inclus avec l'appareil.**

Danby Products Limited, Guelph, Ontario, Canada N1H 6Z9  
Danby Products Inc. Findlay, Ohio, U.S.A.45840

---

## WELCOME

---

Thank you for choosing a Danby appliance to provide you and your family with all of the "Home Comfort" requirements of your home, cottage, or office. This Owner's Use and Care Guide will provide you with valuable information necessary for the proper care and maintenance of your new appliance. If properly maintained, your Danby appliance will give you many years of trouble free operation. Please take a few moments to read the instructions thoroughly and familiarize yourself with all of the operational aspects of this appliance.

This unit can be conveniently moved from room to room within your home and set up in just minutes.

For easy reference, may we suggest you attach a copy of your sales slip/receipt to this page, along with the following information, located on the rear wall of the water tank compartment.

**Model Number:** \_\_\_\_\_

**Serial Number:** \_\_\_\_\_

**Date of Purchase:** \_\_\_\_\_

This information will be necessary if your unit requires servicing and/or for general inquiries.  
To contact a Customer Service Representative, call Danby TOLL FREE:

1-800-26-**Danby**<sup>®</sup>  
(1-800-263-2629)

**KEEP THESE INSTRUCTIONS FOR FUTURE REFERENCE.**

 **CAUTION: Do not leave this unit unattended or operate in an area where people or animals may not be able to react quickly. A failed unit may cause over-heating, resulting in personal injury or property damage.**



---

## IMPORTANT SAFETY INFORMATION

---

### NOTE

The WARNING instructions issued in this manual are not meant to cover all possible conditions and situations that may occur. It must be understood that common sense, caution, and carefulness are factors that cannot be built into all appliances. These factors must be supplied by the person(s) installing, maintaining, or operating the appliance. Failure to install, maintain, and/or operate the equipment according to the manufacturer's instructions may result in conditions which can produce bodily injury and/or property damage. Contact your dealer, service agent, or the manufacturer about any problems or conditions you do not fully understand.

For Danby Customer Service call 1-800-26-**Danby**® (1-800-263-2629)

---

### ELECTRICAL REQUIREMENTS

To reduce the risk of fire, electric shock, or personal injury, all wiring and grounding must conform with the latest edition of Local and National Electrical codes.

- It is the customer's responsibility to have the wiring and fuses checked by a qualified electrician to make sure adequate electrical power is available.
- This appliance is designed to operate on a separate branch, polarized, three-wire, effectively grounded 120 Volt 60 Hertz (alternating current) circuit protected by a 15 ampere fuse, equivalent fuse or circuit breaker. The three-prong grounding plug on the power cord should be plugged directly into a polarized, three slot, effectively grounded receptacle rated 110/120 V.A.C.

**FOR YOUR SAFETY:** To reduce the risk of fire or explosion, do not store or use gasoline or other flammable vapors or liquids in the vicinity of this or any other appliance.

---

### GROUNDING INSTRUCTIONS

Improper connection of the equipment-grounding conductor can result in a risk of electrical shock. Check with a qualified electrician or serviceman if you are in doubt as to whether your appliance outlets are properly grounded.

- This appliance must be grounded. In the event of malfunction or breakdown, grounding will reduce the risk of electrical shock by providing a path of least resistance for electrical current. This appliance is equipped with a cord having an equipment-grounding conductor and 3 prong grounding plug. The plug must be connected into an outlet that is properly installed and grounded in accordance with all local codes and ordinances.
- Do not modify the plug provided with this appliance. If it will not fit the outlet, have a proper outlet installed by a qualified electrician.
- If the household electrical supply does not meet the above specifications, or if you are not sure your home has an effective ground, have a qualified electrician or your local electrical utility company check it and correct any problems.

**SAVE THESE INSTRUCTIONS!**

---

# INSTALLATION INSTRUCTIONS

---

## LOCATION

- Select a suitable location, making sure you have easy access to an electrical outlet (avoid the use of extension cords). If it is absolutely necessary to use an extension cord, use an approved "air conditioner" heavy duty extension cord ONLY (available at most local hardware stores).
- Make sure there are no obstructions restricting airflow through the front air intake grill. Maintain a minimum clearance of at least 20 cm (8") between adjacent walls and the back of the unit, to allow for proper air circulation and maximum efficiency. To obtain maximum operating efficiency from your dehumidifier, the recommended (room ambient) operating temperatures should be between 6°C (42.8°F)- 35°C (95°F).
- It is important to remember the efficiency of a dehumidifier will be effected/influenced by the rate at which new humid air (moisture) is allowed to infiltrate the same space/area. To maintain efficiency, the dehumidifier must be operated in an enclosed area. Keep all doors and windows closed.

---

## FEATURES

---

- Soft touch (Electronic) Control Key Pads
- Auto-Sensing Humidity Control
- Adjustable Humidity Settings (30% - 90%)
- 2 Fan Speed Settings (High / Low)
- Delay Start Protection (Compressor)
- Auto-Defrost (De-Icer)
- Full Bucket Indicator Light
- Easy Roll Castors (4)
- Front Mounted Water Tank (Removable)
- Direct Drain Option
- Quiet Operation
- Removable Air Filter

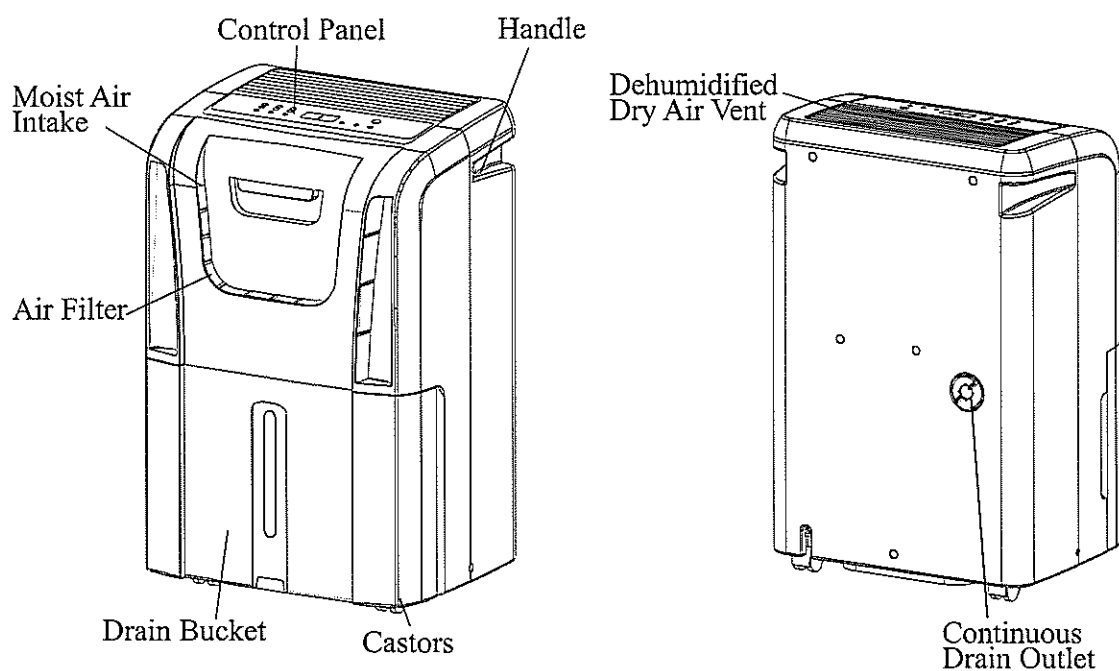

# OPERATING INSTRUCTIONS

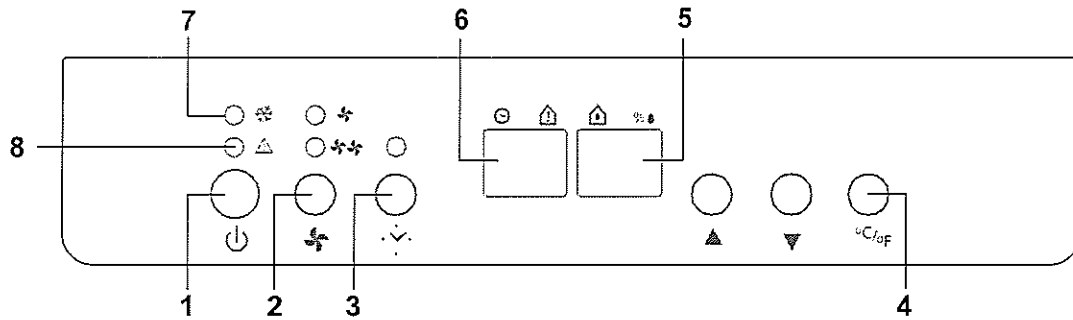

**1) POWER Button:** On / Off

**2) FAN SPEED Button:** High / Low

**3) TIMER Button:** When unit is operating, press TIMER to set number of hours desired until unit will shut off. When unit is in stand-by, press TIMER to set number of hours desired until unit will turn on.

Setting timer from 1-24 hours. To cancel the timer, proceed as above but set the "timer off" to zero (0) hours.

**4) °C/°F Button:** Press the °C/°F button to toggle between Celsius and Fahrenheit.

**5) SET HUMIDITY/CURRENT HUMIDITY DISPLAY:** When machine is running, it displays the

current humidity. Press UP or DOWN buttons to select humidity setting. The humidity is adjusted in increments of 5% by each press. Adjustable range is within 30% RH to 90% RH. 10 seconds after setting humidity, the display will change back to the current humidity.

**6) CURRENT TEMP/ TIMER SET DISPLAY:** When machine is running, it displays the current temperature. Press the TIMER button to set the machine to shut off automatically after specified amount of time. 10 seconds after displaying the timer, the display will change back to current temperature.

**7) DEFROST LIGHT:** When temperature is low, unit enters defrost mode and defrost light illuminates.

**8) BUCKET FULL LIGHT:** When water tank is full, bucket full light illuminates.

## OPERATING INSTRUCTIONS (cont'd)

### START OPERATION

1) Place the product in an upright position on a flat, stable, and heat-resistant surface. Make sure there is nothing flammable or heat sensitive within 100cm (39 inches). Operating the product in any other position could cause a hazard.

2) Insert the plug into a suitable wall socket. The dehumidifier is suitable for operating on an electricity supply having the same voltage as that shown

on its rating label.

3) Make sure the water tank is correctly located. After switching on the machine for the first time, if the "Bucket Full" light illuminates, pull out the water tank and check that the "float" lever is able to move freely, then return the water tank to the correct position (Fig. 1).

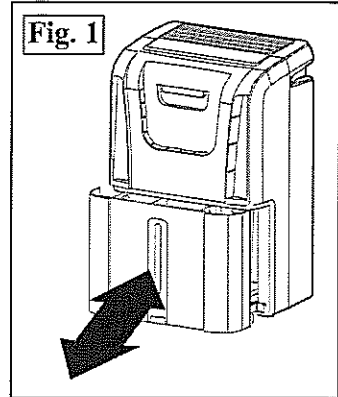

### WATER FULL INDICATOR LIGHT (RED)

When the water tank is full and/or incorrectly positioned inside the cabinet, the water full red light turns on and remains on until such time that the tank is emptied and/or correctly re-positioned.

This condition will result in the immediate shut down of the dehumidifying system (both compressor and fan motor operations are terminated). This is a safety feature. When the water tank is emptied and/or correctly re-positioned, the dehumidifier will resume operation automatically.

**NOTE:** It may take several minutes before operating conditions resume.

### BUCKET FULL LIGHT

- When the water tank is full the machine will stop and the "Bucket Full" light will illuminate.
- The water tank should be carefully removed from the machine by sliding it outward from the front of the unit, and it should be emptied. When the empty tank is replaced properly in the machine, the unit will start up and run normally (Fig. 2).

**NOTE:** Please use both hands to carefully empty the water tank.

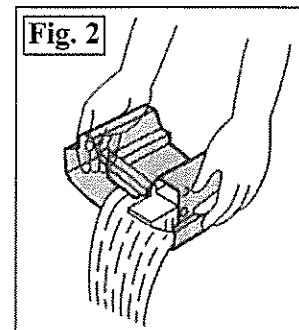

### MEMORY SETTING

Each time the unit is disconnected/reconnected and/or in the event of a power failure, the electronic circuitboard automatically defaults to the last program setting that was set by the user.

### WATER TANK OPERATION

Proper installation of the water tank is crucial in maintaining reliable dehumidifier operation. The water tank holds accumulated condensed water and, by means of a safety switch, controls both the water level and operation of the dehumidification process.

When the water tank is full and/or accidentally displaced inside the cabinet, the float switch actuator (inside the tank) breaks contact with the safety switch. This condition results in the immediate shut down of the compressor and fan motor system, preventing moisture from being condensed.

**NOTE:** Never tamper with or attempt to defeat the water level (safety) float switch system.

# OPERATING INSTRUCTIONS (cont'd)

## DEFROST

When the machine is operated at low temperatures (less than 18°C(64.4°F)), the surface of the evaporator may accumulate a layer of frost which would reduce the efficiency of the machine. When this happens the machine will go into periodic defrost mode. The machine will operate in temperatures down to 5°C(41°F).The time taken to defrost may vary. If the machine freezes up, it should be turned off at the power supply and re-started. If the room temperature remains below 5°C (41°F) the machine should be switched off.

## DEHUMIDIFYING

Dehumidifying is a means of removing moisture from the air. A dehumidifier will help to protect your home and valued possessions from damage (swelling) caused by moisture in the air. Essentially a dehumidifier removes moisture from the air as the moist air passes over a dehumidifying (evaporator) coil. Moisture is condensed on the evaporator coil, drained, and collected inside an internal (removable) water tank located at the front of the unit. The exhausted air being returned into the room environment is elevated several degrees, causing the surrounding air temperature to increase (slightly). This process also contributes to lowering the

relative humidity of the surrounding air.

### DEHUMIDIFYING MODE SELECTION:

- 1) To turn the unit on, press the ON / OFF button.
- 2) Press the humidity or buttons to select a desired RH operating value (30%-90%).

**FAN SPEED SELECTION:** Select a fan speed on the keypad. The speed you select is identified by the (illuminated) indicator light located directly above the selection made.

## AIR FILTER

Your dehumidifier features a removable Air Filter. This filter is located at the front of the unit (behind the air intake grill) directly above the water tank compartment. The air filter plays an important role in helping to reduce (minimize) dust/dirt particles from the surrounding environment. A blocked / clogged air filter reduces air intake, impacting negatively on operating efficiency. To maintain maximum operating efficiency, the filter must be checked and cleaned regularly (every 2 weeks). More frequent cleaning may be required depending upon indoor air quality.

**IMPORTANT:** Never operate the unit without the air filter in place.

### AIR FILTER CLEANING STEPS:

- 1) Pull the air filter out gently (Fig. 3).
- 2) Clean the filter with a vacuum cleaner, or wash it with clean water and dry with a dry cloth.
- 3) Put the clean air filter back in place and continue to operate the dehumidifier.

Fig. 3

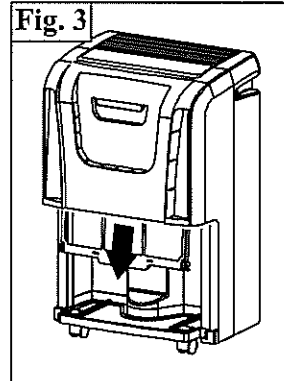
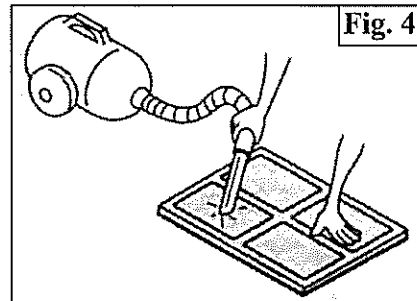

Fig. 4



## OPERATING INSTRUCTIONS (cont'd)

### INSTALLING PVC DRAIN HOSE

When using the continuous drain function, the PVC hose must be placed horizontally below the drainage hole. Avoid uneven ground and folding the hose. **NOTE:** Should you damage or misplace the pvc drain hose, a standard garden hose can be used.

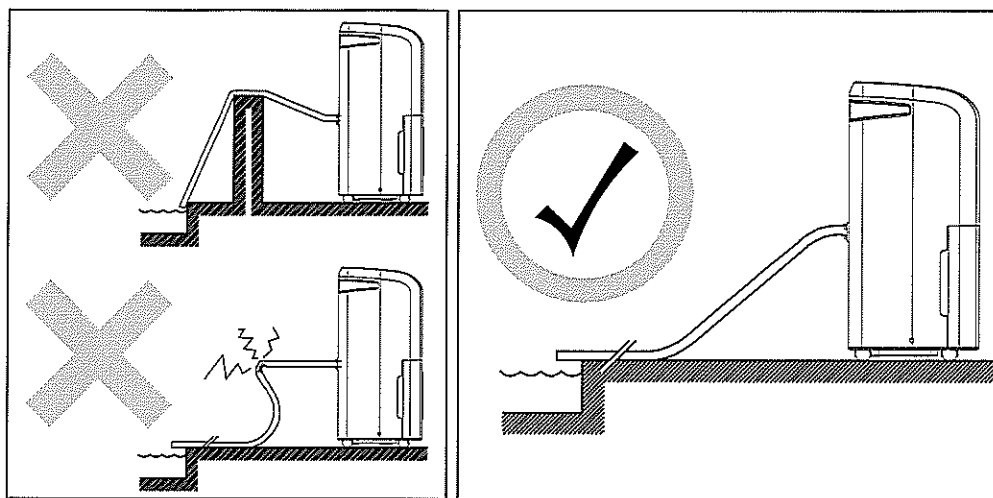

### CONTINUOUS DRAIN

The function of continuous drain can be performed using the following steps:

- 1) To save having to periodically empty the water tank, this unit can be configured for continuous drain. You can use the supplied drain hose to connect to the continuous drain connector.
- 2) Unscrew and remove the drain cover at the rear of the unit (Fig. A).
- 3) Remove the soft rubber stopper, and place it in the water tank for safe keeping (Fig. B).
- 4) Insert the drain hose through the hole of the drain cover (Fig. C).
- 5) Ensure the rubber seal ring is properly seated in the end of the hose as shown in Fig. C.
- 6) Connect the drain hose to the drain port (Fig. D).
- 7) Tighten the drain cover in clockwise direction onto the rear of the unit (Fig. D).
- 8) Place the bucket in its original location (Fig. E).

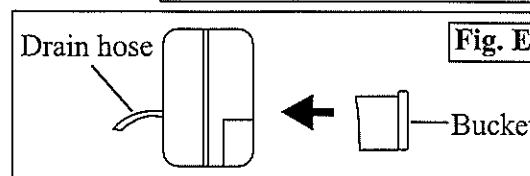
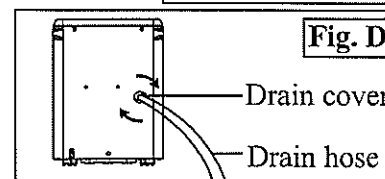
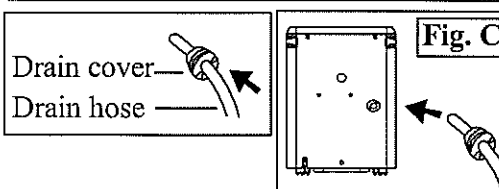
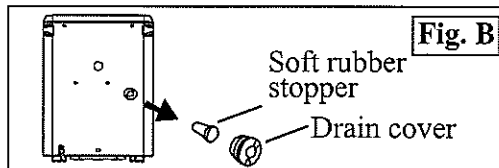
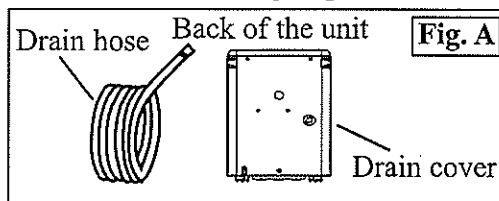



## CAUTIONS

1) **DO NOT** pull on the power cord to avoid breakage, potential danger, or injury.

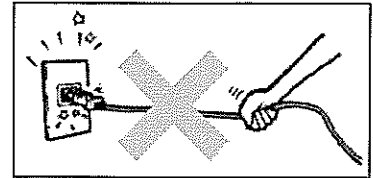

2) **DO NOT** use insect/oil/paint spray around the machine; these products might cause damage to plastic parts or start a fire.

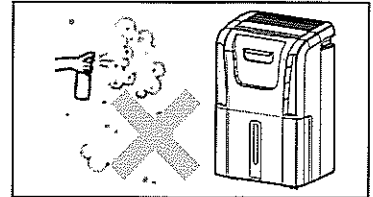

3) **DO NOT** place the unit on uneven ground to avoid shaking, noise, and water leakage.

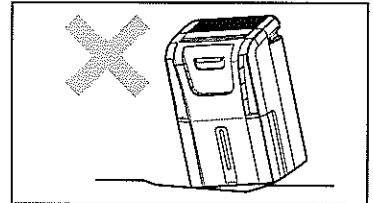

4) Always keep the unit 20cm or more from the wall to dissipate heat properly.

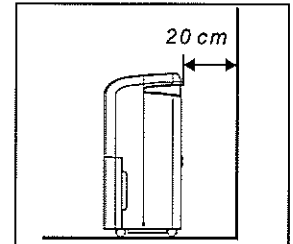

5) **DO NOT** drop anything into the machine.

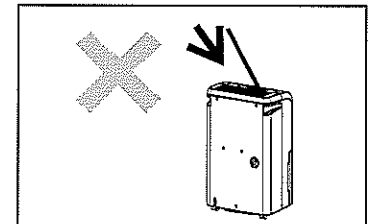

6) Close all windows to allow for the maximum possible efficiency or removal of moisture

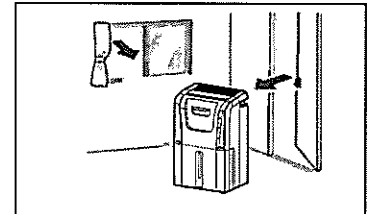

7) Keep the machine away from any type of heat source.

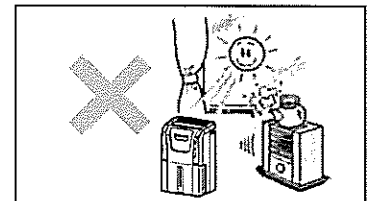

8) When moving or putting in storage, do not place the dehumidifier on its side, or upside down, to avoid shaking.

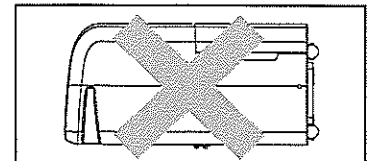

---

## CARE AND MAINTENANCE

---

### CLEANING



**CAUTION:** Before attempting to clean and/or service this unit, always disconnect the power supply cord from the electrical supply outlet.

- 1) **DO NOT** use gasoline, benzene, paint thinner, or any other chemicals to clean this unit, as these substances will damage/deform both plastic components and luster finish.
- 2) Never attempt to clean the unit by pouring water directly over any of the surface areas, as this will cause deterioration of electrical components and wiring insulation.
- 3) Use only a mild dish washing detergent, lukewarm water, and a soft cloth to wipe the exterior surface of the unit and dry thoroughly.

---

### STORAGE

When the dehumidifier is not being used for long time periods, please follow these instructions:

- 1) Disconnect the power cord from the power supply.
- 2) Empty the water tank and wipe (clean) thoroughly.
- 3) Clean air filter thoroughly.
- 4) Re-package the unit in the original carton
- 5) Store the unit upright in a dry location.

---

## TROUBLESHOOTING

---

Occasionally, you may encounter some problems that are of a minor nature and a service call may not be necessary. Use this troubleshooting guide to identify possible problems you may be experiencing. If the unit continues to operate improperly, call your local Danby Service Depot or  
**1-800-26-Danby® (1-800-263-2629)**

PROBLEM	POSSIBLE CAUSE
1) Unit will not operate.	<ul style="list-style-type: none"><li>• Check power cord connection.</li><li>• Check electrical outlet for blown fuse.</li><li>• Check if water tank is full (if yes, empty).</li><li>• Check water tank is properly installed.</li></ul>
2) Dehumidifying capacity (moisture removal) low.	<ul style="list-style-type: none"><li>• Air filter is dirty and/or blocked.</li><li>• Ambient (room) temperature too low (below 5°C/41°F).</li><li>• Poor air flow circulation/obstruction of front grill.</li><li>• Relative humidity in surrounding environment very low.</li></ul>
3) Relative Humidity setting not reached after long period of operation.	<ul style="list-style-type: none"><li>• Check all doors and windows are closed.</li><li>• Area/room is too large for the capacity of the dehumidifier.</li></ul>



## LIMITED APPLIANCE WARRANTY

This quality product is warranted to be free from manufacturer's defects in material and workmanship, provided that the unit is used under the normal operating conditions intended by the manufacturer.

This warranty is available only to the person to whom the unit was originally sold by Danby Products Limited (Canada) or Danby Products Inc. (U.S.A.) (hereafter "Danby") or by an authorized distributor of Danby, and is non-transferable.

### TERMS OF WARRANTY

Plastic parts, are warranted for thirty (30) days only from purchase date, with no extensions provided.

*First 24 Months* During the first twenty four (24) months, any functional parts of this product found to be defective, will be repaired or replaced, at warrantor's option, at no charge to the ORIGINAL purchaser.

*To obtain Service* It will be the consumer's responsibility to transport the appliance (at their own expense) to the original retailer (point of purchase) or a service depot for repair. Contact your dealer from whom your unit was purchased, or contact your nearest authorized Danby service depot, where service must be performed by a qualified service technician.

If service is performed on the unit by anyone other than an authorized service depot, or the unit is used for commercial application, all obligations of Danby under this warranty shall be void.

Nothing within this warranty shall imply that Danby will be responsible or liable for any spoilage or damage to food or other contents of this appliance, whether due to any defect of the appliance, or its use, whether proper or improper.

### EXCLUSIONS

Save as herein provided, Danby, there are no other warranties, conditions, representations or guarantees, express or implied, made or intended by Danby or its authorized distributors and all other warranties, conditions, representations or guarantees, including any warranties, conditions, representations or guarantees under any Sale of Goods Act or like legislation or statute is hereby expressly excluded. Save as herein provided, Danby shall not be responsible for any damages to persons or property, including the unit itself, howsoever caused or any consequential damages arising from the malfunction of the unit and by the purchase of the unit, the purchaser does hereby agree to indemnify and hold harmless Danby from any claim for damages to persons or property caused by the unit.

### GENERAL PROVISIONS

No warranty or insurance herein contained or set out shall apply when damage or repair is caused by any of the following:

- 1) Power failure.
- 2) Damage in transit or when moving the appliance.
- 3) Improper power supply such as low voltage, defective house wiring or inadequate fuses.
- 4) Accident, alteration, abuse or misuse of the appliance such as inadequate air circulation in the room or abnormal operating conditions (extremely high or low room temperature).
- 5) Use for commercial or industrial purposes (ie. If the appliance is not installed in a domestic residence).
- 6) Fire, water damage, theft, war, riot, hostility, acts of God such as hurricanes, floods etc.
- 7) Service calls resulting in customer education.
- 8) Improper Installation (ie. Building-in of a free standing appliance or using an appliance outdoors that is not approved for outdoor application).

Proof of purchase date will be required for warranty claims; so, please retain bill of sale. In the event warranty service is required, present this document to our AUTHORIZED SERVICE DEPOT.

**Warranty Service**  
Carry-In

Danby Products Limited  
PO Box 1778, Guelph, Ontario, Canada N1H 6Z9  
Telephone: (519) 837-0920 FAX: (519) 837-0449

**1-800-263-2629**

04/09

Danby Products Inc.  
PO Box 669, Findlay, Ohio, U.S.A. 45840  
Telephone: (419) 425-8627 FAX: (419) 425-8629